

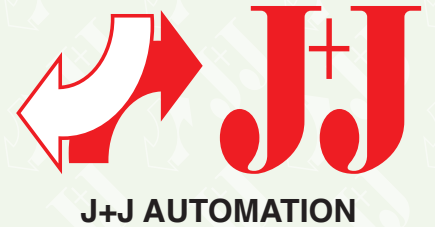





**technische import**

# J+J Handleiding

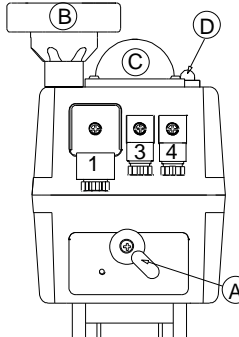
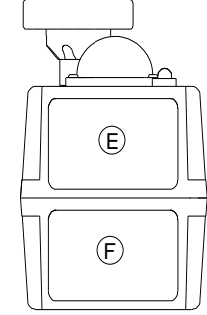

<b>General explanations</b>	<p>The electromechanical vane actuators <b>J+J®</b> for manipulation of industrial valves with an angle of traverse of 0-90° / 0-180° or a freely definable angle of traverse are assembled quite compactly and equipped completely to be taken in use without problems. Because of the clear structure and the maintenance-free operation, flexibility and security as well as the mechanical unblocking the actuators are straightforward and tolerant towards errors in use. This tolerance is supported by versatile systems as ETL (Electronic Torque Limiting), AVS (Automatic Voltage Sensing), ATC (Automatic Temperature Control) and PEC (Protected Consistent Electrical Connection) to improve quality and handling.</p>																																							
<b>Function</b>	<p>The actuators are driven by engines which are connected with the mainshaft through gears. Through redirecting these gears, it is possible to declutch the engines on manual working. Here the current of the engine is interrupted. As the manual emergency manipulation is firmly installed, the armature can be operated via handwheel or via locking handle right after switching over. The travel stops take place through 2 integrated micro-switches. These switches are operated through cams which are placed directly onto the mainshaft. Beyond that there are 2 further, floating limit switches for signal generating. There is no mechanical travel stop. The optical position indicator on the actuator gives information about the position of the armature. At the interface of the armature, which is conforming to standards, appropriate armatures can be mounted directly or with the help of suitable adapters. The electrical connection is made by plugs. A nameplate as well as a socket plan / connection diagram makes it easy to identify the actuator.</p>																																							
<b>Manual override</b> 	<p>All <b>J3C</b> actuators are supplied with a declutchable manual override to allow operation should power not be available. The <b>J3C</b> actuator has 2 operating modes, automatic and manual, the required mode is selected using a lever on the lower half of the actuator housing. The 2 positions are marked:  AUTO = Automatic operation  MAN = Manual operation  When "MAN" function is selected:  1 The electronic system cuts the power to the motor.  2 The motor to output shaft drive is disconnected.  3 The desired position can be achieved using the manual override lever or hand wheel.  Remember to select "AUTO" following use in "MAN" function as the actuator only responds to electrical open and close commands when in "AUTO".  In model -20 to 85 the manual override lever/hand wheel rotates when the actuator is being powered. Do not obstruct or restrict this rotation.  <b>Warning:</b> Do not remove the selector lever securing cross head screw as this will allow its internal mechanism to become loose and will cause irreparable damage to the actuator's gearbox. Removing this screw will invalidate the warranty</p>																																							
<b>Status Light</b> 	<p>The actual actuators status is shown up by the colored status light/ LED on the actuators head. The meaning of the colours and the configuration are shown in the following.</p> <table border="1" data-bbox="336 1039 1490 1350"> <thead> <tr> <th>Actuator operation status</th> <th>time</th> <th>configuration</th> <th>LED colour</th> </tr> </thead> <tbody> <tr> <td>Actuator without power being supplied</td> <td>100%</td> <td>0000 0000 0000 0000</td> <td>LED off</td> </tr> <tr> <td>Actuator with power being supplied / in "open" position"</td> <td>100%</td> <td>1111 1111 1111 1111</td> <td>green</td> </tr> <tr> <td>Actuator with power being supplied / in "close" position"</td> <td>100%</td> <td>1111 1111 1111 1111</td> <td>red</td> </tr> <tr> <td>Actuator moves from „open“ to „close“</td> <td>100%</td> <td>1111 1111 1111 1111</td> <td>red / orange (flashing)</td> </tr> <tr> <td>Actuator moves from „close“ to „open“</td> <td>100%</td> <td>1111 1111 1111 1111</td> <td>green / orange (flashing)</td> </tr> <tr> <td>Actuator with torque limiter activated direction "close"</td> <td>200msec</td> <td>1010 1010 1010 1010</td> <td>red (flashing)</td> </tr> <tr> <td>Actuator with torque limiter activated direction "open"</td> <td>200msec</td> <td>1010 1010 1010 1010</td> <td>green (flashing)</td> </tr> <tr> <td>Actuator is in MANUAL mode (motor stops)</td> <td>200msec</td> <td>1111 0111 1000 0000</td> <td>orange (flashing)</td> </tr> </tbody> </table>				Actuator operation status	time	configuration	LED colour	Actuator without power being supplied	100%	0000 0000 0000 0000	LED off	Actuator with power being supplied / in "open" position"	100%	1111 1111 1111 1111	green	Actuator with power being supplied / in "close" position"	100%	1111 1111 1111 1111	red	Actuator moves from „open“ to „close“	100%	1111 1111 1111 1111	red / orange (flashing)	Actuator moves from „close“ to „open“	100%	1111 1111 1111 1111	green / orange (flashing)	Actuator with torque limiter activated direction "close"	200msec	1010 1010 1010 1010	red (flashing)	Actuator with torque limiter activated direction "open"	200msec	1010 1010 1010 1010	green (flashing)	Actuator is in MANUAL mode (motor stops)	200msec	1111 0111 1000 0000	orange (flashing)
Actuator operation status	time	configuration	LED colour																																					
Actuator without power being supplied	100%	0000 0000 0000 0000	LED off																																					
Actuator with power being supplied / in "open" position"	100%	1111 1111 1111 1111	green																																					
Actuator with power being supplied / in "close" position"	100%	1111 1111 1111 1111	red																																					
Actuator moves from „open“ to „close“	100%	1111 1111 1111 1111	red / orange (flashing)																																					
Actuator moves from „close“ to „open“	100%	1111 1111 1111 1111	green / orange (flashing)																																					
Actuator with torque limiter activated direction "close"	200msec	1010 1010 1010 1010	red (flashing)																																					
Actuator with torque limiter activated direction "open"	200msec	1010 1010 1010 1010	green (flashing)																																					
Actuator is in MANUAL mode (motor stops)	200msec	1111 0111 1000 0000	orange (flashing)																																					
<b>Standard equipments</b>	<p>All <b>J3C</b> actuators are fitted with an electronic torque limiter (ETL). The function is shown via LED in the cover. (See chapter: status light). The ETL automatically backs off when activated to relax the gears, allowing the manual override to be used to assist in clearing the blockage. (Auto Temperature Control): An inbuilt thermostat and heater maintains the internal temperature at around 30°C to prevent the possibility of condensation forming within the housing. This system does not require a separate power supply, it is fed from the main power supply. The power supply must remain on at all times for the heater to operate. All <b>J3C</b> actuators have a manual override facility to allow manual operation in the event of power failure. Selection of manual ("MAN") operation operates after a few seconds (4xworkingtime) cuts the motor power  All <b>J3C</b> actuators have an additional pair of volt free mechanical micro-switch contacts which are typically used for remote position confirmation. These switches are NOT to be used for actuator motor control.</p>																																							
<b>Optional accessories</b>	<ul style="list-style-type: none"> <li>- <u>Potentiometer</u>: With the special equipment „potentiometer“ is possible a resistance-dependent position sensing of the drive.</li> <li>- <u>AKKU- Safetypack/BSR</u>: The BSR safety pack contains a battery inclusive load electronics, which ensures with power failure a safety adjustment (open or close) to the valve.</li> <li>- <u>Positioner DPS, or potentiometer and BSR safety pack</u>: DPS position control system is available with 4-20mA or 0-10V. Input and Output signal are standard for this model. The signal have to be voltfree.</li> </ul> <p><b>For all special models are complementary instructions! Please look at the separate manual.</b></p>																																							

<b>Mounting</b>	The <b>J+J®</b> actuators may not install overhead. (Flange upwards) Please consider the accessibility of the hand emergency manipulation and the visibility of the position indicator. Depending on the type, the actuator is adjusted according to the print. Possibly the angle of traverse as to be adapted corresponding to the armature. With applications in the external area the actuator has to be protected by suitable measures in order to keep the permissible temperature range. To avoid condensation one should respect the wiring variant for switch room heating. Beyond that the actuators have to be protected against environmental influences (rain, snow, etc.) in order to avoid any malfunction or failure. On part of the plant construction and/or the operator maintenance cycles and test cycles have to be stipulated according to the employment- and safety requirements. Beyond that one has to go into the particulars of control characteristics with the help of guidance and documentations.
<b>Connection</b>	All <b>J+J®</b> actuators have to be connected single-phase, have to be mutual bolted and actuated by a relay or a switch - No parallel consumers. Please intend an external fuse. The connection occurs by means of the provided wall plugs. Here one should pay attention to the suitable cable diameter because otherwise the tightness is not ensured. In principle, the wiring suggestions, the tensions and other data presented on the print of the actuator are valid. With discrepancies and any malfunctions, you should absolutely confer in order to avoid destruction or damages. Complete units, consisting of armature and actuator, only have to be wired over the plugs. Opening the actuator is only necessary if one has to adjust it. Connection, start-up or opening of the actuators may only take place by technical personal considering VDE regulations.
<b>Maintenance</b>	These actuators are designed to be maintenance free, the gearbox is factory lubricated for life and there are no internal parts that require maintenance. With rarely used actuators it is recommended to carry out a rule examination of the functions in accordance with the safety requirements. After the start-up, the connection between actuator and armature should be examined after some running time. Here the operation smoothness of the armature has to be examined, too. Generally, one has to pay attention to the close seat of the cover and the tightness of the cable gland. Unused plugs have to be locked.
<b>Notice</b>	The interface of the armature has to be arranged according to DIN3337/ISO5211 and has to guarantee an alignment of actuator and the driving shaft of the armature. The driving shaft of the armature has to be shorter than accommodation of the actuator. The technical requirements have to be according to the performance data of the actuators. A blocking of the driving shaft or the manual operating facilities may cause damages on the actuator. It is vital that the mounting kit used to connect the electric actuator to the component being actuated (eg: valve) is correctly manufactured and assembled. The mounting bracket's holes must be drilled to ensure that the centerline of the actuator's drive is perfectly in line with the component's drive centerline, and that the drive coupling/ adaptor rotates around this centerline. The mounting holes of the actuator conform to ISO 5211, and the female output drive conforms to DIN 3337. We strongly recommend that valves/ components to be actuated that have ISO 5211 compliant topworks are used wherever possible as is greatly assists in ensuring the concentricity of mounting the actuator to the valve. The male square end of the drive coupling <b>MUST NOT</b> be longer than the maximum depth of the actuator female output drive when the assembly is bolted together. Failure to comply with these instructions will cause uneven wear and dramatically reduce the working life of the valve and actuator.
<b>Set in operation</b>	<p><u>Before start-up please check the following circumstances:</u></p> <ul style="list-style-type: none"> <li>- Does the actuator correspond to the demanded model? (Torque, protection class, voltage, etc.)</li> <li>- Does the wiring correspond to the kind of tension (see diagram)</li> <li>- Can the armature be operated via hand emergency manipulation without large energy expenditure?</li> <li>- Is there a switch room heating necessary? (With reaching the end positions the tension has to remain on)</li> </ul>
<b>Malfunction</b>	<ul style="list-style-type: none"> <li>- It does not pass nothing: Switch from manual to open. Wiring (AC or DC) is attached the plug? Does tension arrives the plug?</li> <li>- The drive starts and remains then standing: At the long side of the drive flashes in the housing a red light (if necessary only with opened drive recognizably - to open only by technical personnel!) Limiter actively, valve difficult to operate or blocks or for operation by the drive model unsuitably. Eliminate reason for overloading or select stronger drive.</li> <li>- It is recognizable no flare signal: External safety device or fuse blown / if necessary replace wiring fuse.</li> <li>- Drive stands on open, valve is however closed or for valve opens and closes not completely drive rotated developed or end position adjustment agrees not with valve: The releasing cams must again be adjusted, and/or the drive is to be developed correctly. The limit switches for position signal do not react to wiring examine: adjustment of the releasing cams in such a way examine and stop that the switches are operated briefly before reaching the procedure way border.</li> <li>- The drive proceeds, which valve however not adjusts: the interface between valve and drive is incorrectly or defectively, hold consultation with the supplier and examine if necessary total documentation.</li> <li>- The end position is reached, the Limiter is active (light flashes): mark the position of the position-indication, switch to Manual and turn back drive manually easily from the final position and turn again in direction of the final position.</li> <li>- Do you encounter increased reconditions must the valve be examined have the valve of final notices those were not removed &gt; notices to remove condition foreign matter in the valve (cloth around shut-off valve, solids in death areas or the like), are defective the seal? &gt; valve repair/ consultation with valve supplier hold. The integrated Limiter represents a protection device, in order to Avoid damage for such problems, a constant utilization (e.g. drive on valve notices) can however to damage to valve, adapters and drive follow. Such errors must be eliminated thus as fast as possible.</li> </ul>

view plugs:	description:	connector:	cable diameter:												
 <p>1 main supply 3 options – auxillaries: connector for positioner (input/output), output potentiometer 4 connector for extra limit switches A manual/ automatic switch (AUTO / MAN) B handwheel – optical position indicator and manual override C optical position indicator D status light</p>	 <p>E wiring diagram F label</p>	 <p>1 gasket 2 terminal strip 3 cable fixing screw 4 housing 5 grommet 6 washer 7 gland nut 8 fixing screw 9 plate 10 sealing</p>	 <p>connector DIN-EN175301-803</p> <table border="1"> <tr> <th colspan="2">big connector (type a) DIN-EN175301-803</th> </tr> <tr> <th>min. diameter</th> <th>max. diameter</th> </tr> <tr> <td>8mm</td> <td>10,5mm</td> </tr> <tr> <th colspan="2">small connector (type c) industrial standard</th> </tr> <tr> <th>min. diameter</th> <th>max. diameter</th> </tr> <tr> <td>5mm</td> <td>6mm</td> </tr> </table>	big connector (type a) DIN-EN175301-803		min. diameter	max. diameter	8mm	10,5mm	small connector (type c) industrial standard		min. diameter	max. diameter	5mm	6mm
big connector (type a) DIN-EN175301-803															
min. diameter	max. diameter														
8mm	10,5mm														
small connector (type c) industrial standard															
min. diameter	max. diameter														
5mm	6mm														

**technical data:**

model	max. current consumption/ max. output on 24 - 240V AC/DC				torque Nm	working time for 90°/ without valve (+/- 10%)	weight
	24V AC	24VDC	110VAC	230VAC			
S20	1,2A / 28,8W	0,8A / 19,2W	0,3A / 33W	0,2A / 46W	20Nm / 25Nm	10sec.	1,8Kg
S35	1,6A / 38,4W	1,2A / 28,8W	0,3A / 33W	0,2A / 46W	35Nm / 38Nm	10sec.	1,9Kg
S55	1,8A / 43,2W	1,3A / 31,2W	0,4A / 44W	0,2A / 46W	55Nm / 60Nm	14sec	2,4Kg
S85	1,2A / 28,8W	0,9A / 21,6W	0,3A / 33W	0,2A / 46W	85Nm / 90Nm	30sec	3Kg

**main data:**

duty	temperature range	heater	safety class IEC60529	endposition -switches
ED = 75%	-20°C / +70°C	3,5W	IP67	250VAC 3A

**wiring diagram:** wirings for special actuators (DPS, Poti...) please look at the seperate manual

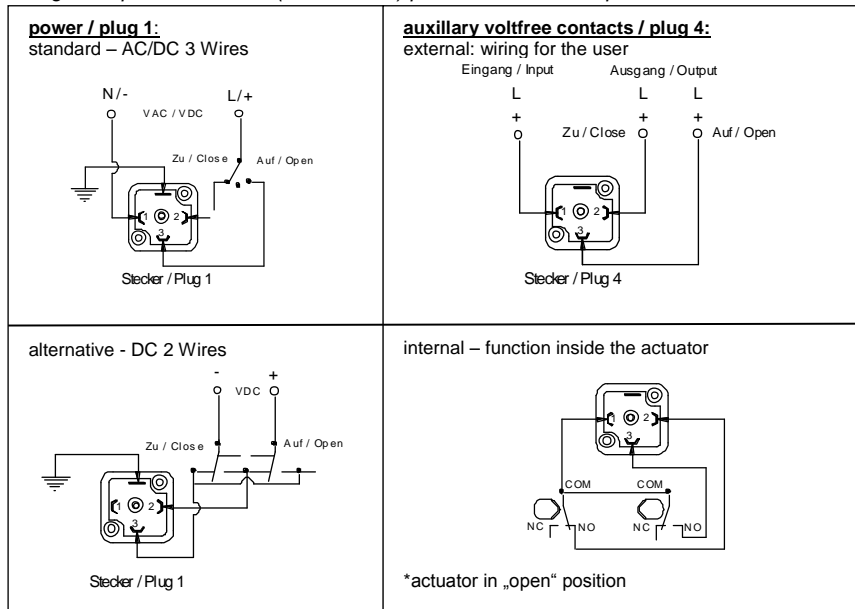

**electrical connectors:**

Warning: Before connecting ensure that the voltage to be applied to the actuator is within of the range shown on the identification label. J3 electric actuators are multi-voltage capable with automatic sensing of the incoming power supply. The J3-S Series accept any voltage, AC or DC, between 24 and 240 volts. The supplied electrical connectors used to connect to the actuator are DIN plugs. Ensure the diameter of cable to be used conforms to the maximum and minimum requirements of the DIN plugs



**adjustment instruction limit switches J3C**

**security advise:** All work in the actuator may be accomplished only by qualified technical personnel and with switched off voltage supply. Affecting live components can have and to the damage of electronics lead a dangerous electrical impact to the consequence!  
**purpose:** The actuators are pre-adjusted. Dependent on the use, lacking aligning of valve connections or adapters, it can be necessary the drive in its stroke ends on the respective valve to adapt or feedbacks circuit differently to adjust. Sometimes a readjusting can become necessary after longer employment under strong vibrations.  
**note:** All screws and seals are to be brought after the assembling into their original position. Consider the references of the valve manufacturer and if necessary instructions of the plant constructor.

**preparing measures:**

1. Plugs after loosening of the fixing screws take off (seals consider).
2. Loosen the screws of the handwheel and take handwheel off.
3. The housing screws loosen and take.
5. Covers carefully straight take off upward and do not rotate (levers with a screwdriver can lead to leakages). Put Covers aside (cables to be able to remain connected with the plate, however absolutely consider them the cable run, which must be restored for the assembly).
6. Put handwheel/ lever or indicator and fix the screws.

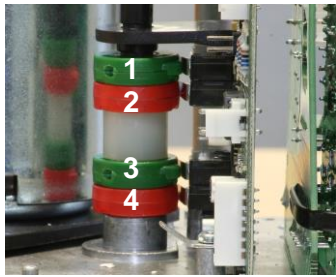
**procedure:** There is a setting tool placed in the actuator. By dint of this tool it is possible to modify the position of the cams and the relevant micro switches. **Note:** A turn from area to area adjusts the travel length about ca. 2°. A complete turn adjusts the travel length about ca.12°. The micro switches assembly are given below. First, the actuator is in the need to be toggled from AUTO to MAN and adjust manually to the requested position. Now stuck the setting tool into the headless screw of the cam and turn it into the wished position till it engages by a click. Only turn the cam out of that direction from where the main shaft is going to turn into that position, right to the micro switching flag. The actuators shutdown must be checked by electrical pull over of the actuator. The response can be checked by a continuity tester. Connect the continuity top connector to terminal 3 on Pin 1 and 2 (closed position) or to Pin 1 and 3 (opened position) (*view wiring diagram*). Switches trigger need to be configured just in that position, where the actuator should shutdown. Certainly, it is possible to adjust every wished position, if you, for example, want to realize intermediate positions.

<p><b>setting tool:</b></p> 	<b>Assembly of cams and micro switches:</b>			
<p>setting tool in use</p> 	cam no.	colour	function	
	1	green	end position feedback position: "opened"	
	2	red	end position feedback position: "closed"	
	3	green	end position feedback position: "opened"	
	4	red	end position feedback position: "closed"	

**assembly:** After conclusion of the adjustment the cover is carefully remounted. Pay attention to lead the cables past as in the starting situation at the waves and the engine so that it cannot come to malfunctions by getting jammed. The cover must rest upon now closely the lower part. This is the case does not lie a cable possibly between engine and cover or is gotten jammed between lower part and cover. The cover lies closely on can you the screws use and crosswise tighten. Put afterwards the flaps position indicator on, the handwheel or the lever put on and fix. After the electrical connections are manufactured and were switched the drive under easy rotation of the handwheel or lever by AUTO to MAN, you can examine the electrical function. If the function should be incorrect, the procedure is to be repeated carefully. In case of questions, please contact the **J+J®** Service.



**technische import**